

TempTap™ Generator Docking Station

UL 1008 Listed

2000A, up to 600VAC
Series: 3622

Features



- Quick connect solution for a backup portable generator
- Hinged, padlockable access door & dead front panel for safe generator connection and operation
- Type 3R double coated, cold-rolled steel enclosure with gray powdercoat RAL 7035 (stainless steel & additional colors optional)
- Color-coded cam style male connectors for easy generator connection
- Unit does not provide overcurrent protection. Must be used with appropriately sized feeder disconnect for intended application
- Pad mount

Drawing

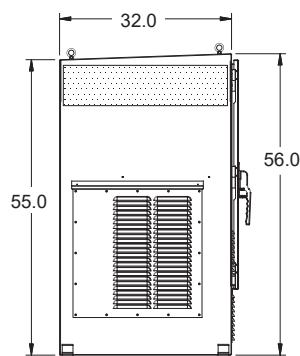

LEFT VIEW

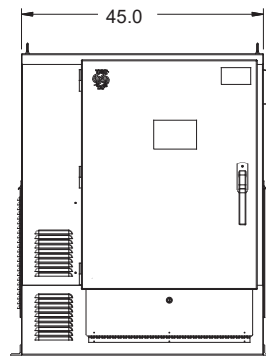

FRONT VIEW

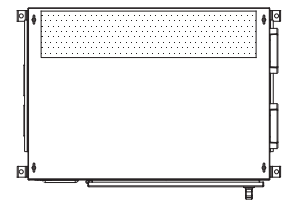

TOP VIEW

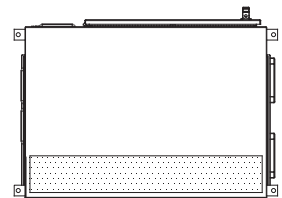

BOTTOM VIEW

Available incoming conduit entry locations shown shaded.

Approvals

- UL/cUL 1008 Listed assembly
- UL 1691 Listed receptacles

Specifications

UL 1008 Listed

TempTap Generator Docking Station Series: 3622

System Voltage	208Y/120 (3-Phases + Neutral + Ground) 208 (3-Phases + Ground) (no Neutral) 240 Delta (3-Phases + Ground) (no Neutral) 240/120 Delta (3-Phases + Neutral + Ground) (High Leg) 480 Delta (3-Phases + Ground) (no Neutral) 480Y/277 (3-Phases + Neutral + Ground) 600 Delta (3-Phases + Ground) (no Neutral) 600Y/347 (3-Phases + Neutral + Ground)	
Assembly Rating	42kAIC @ 240VAC, 480VAC, 600VAC,	
Terminals	Load terminals: (8) 300 - 800kcmil per phase & neutral Ground lug: (4) #2 - 600kcmil Other options available	
Enclosure Material	Standard: Double coated, cold-rolled steel Optional: 304SS, 316SS	
Environmental Rating	Standard: 3R Optional: 3RX for stainless steel	
Enclosure Color Options (additional cost may be required)	Standard: RAL-7035 - Wrinkle Light Gray Optional: RAL-1015 - Wrinkle Light Ivory RAL-1023 - Wrinkle Traffic Yellow RAL-2004 - Wrinkle Pure Orange RAL-3020 - Wrinkle Traffic Red RAL-5002 - Wrinkle Ultramarine Blue	RAL-6024 - Wrinkle Traffic Green RAL-7004 - Wrinkle Signal Gray RAL-7038 - Wrinkle Agate Gray RAL-8017 - Wrinkle Chocolate Brown RAL-9003 - Wrinkle Signal White RAL-9005 - Wrinkle Jet Black
Standard Accessories	Phase Rotation monitor Remote Start 3 Point TB	
Optional Accessories	Pilot Light - Primary Source (Red) Pilot Light - Primary Source (Green) Pilot Light - Alternate Source (Red) Pilot Light - Alternate Source (Green) Infrared Window Kirk Key	Surge Protection Device (SPD) Heater/Thermostat/De-Humidistat Receptacle - 20A, 120V Duplex Receptacle - 20A, 120V GFCI Duplex Receptacle - 20A, 120V Twist Lock Receptacle - 30A, 120V Twist Lock Receptacle - 20A, 120V Straight Blade
Aproximate Product Weight:	650 lbs.	
Aproximate Shipping Weight:	730 lbs.	